

-RCD Id:100 mA
je nach Anlage
nicht zwingend
erforderlich

-NH 100 A

KACO WR 1

-RCD Id:100 mA
je nach Anlage
nicht zwingend
erforderlich

-NH 100 A

KACO WR 2

5G32

5G32

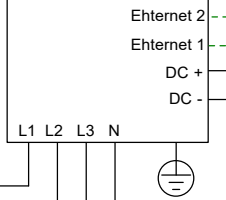
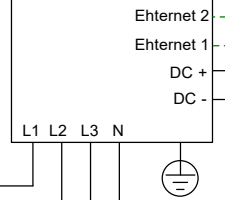

von FEMS Anschlussbox:

Wechselrichter

Batterie

TCP

RS485

Ethernet CAT6

Ethernet CAT6

TCP

RS485

TCP

Ethernet CAT6

Ethernet CAT6

zu KACO WR n

zu Batterie Rack n

1x25 mm²

1x25 mm²

1x25 mm²

1x25 mm²

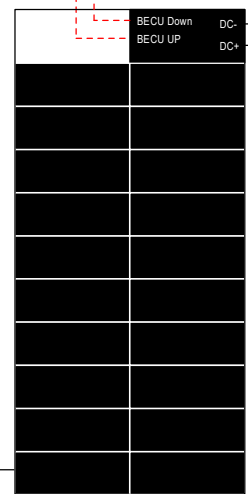

Battery Rack 1

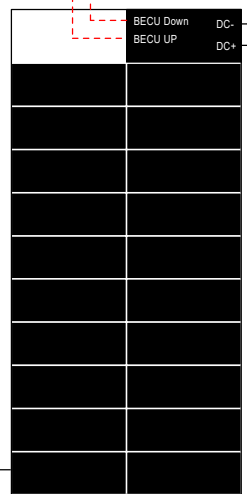

Battery Rack 2



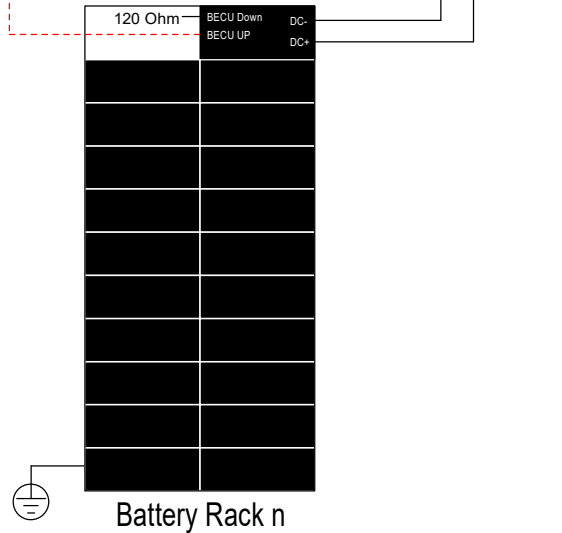
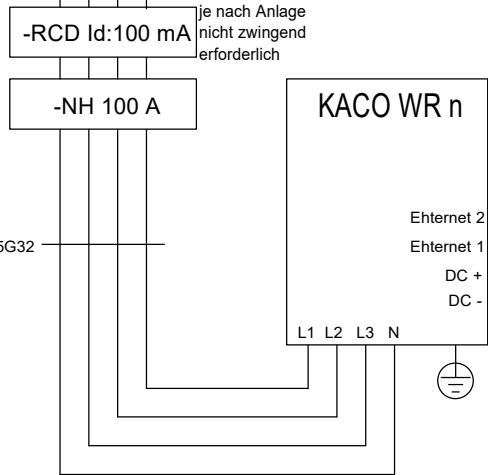
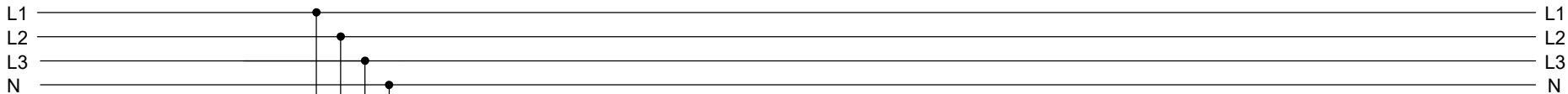

FEMS-Anschlussbox Commercial 50-serie

